

Schaltschrankebene

Auswählbare digitale Kommunikations- und Steuergeräte:

THC24-(1)B G2
für 1 Antrieb (Variante 3.1)



oder

THC24-4B MP
für 4 Antrieb (Variante 3.2)



oder

SLC24-8B
für 8 Antrieb (Variante 3.3)

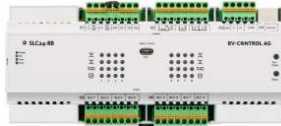

oder

SLC24-16B
für 16 Antrieb (Variante 3.4)

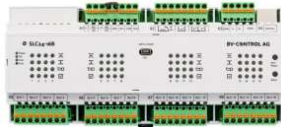

oder

SLC230-24-2B
für 2 Antrieb (Variante 3.5)



SLC230-24-4B
für 4 Antrieb (Variante 3.6)

Feldebene

Zusätzliche Option
Rauchmelder
z.B. ORS 142 K

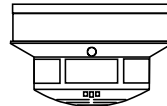

Thermoelektrische
Auslöseeinrichtung:
BAT72

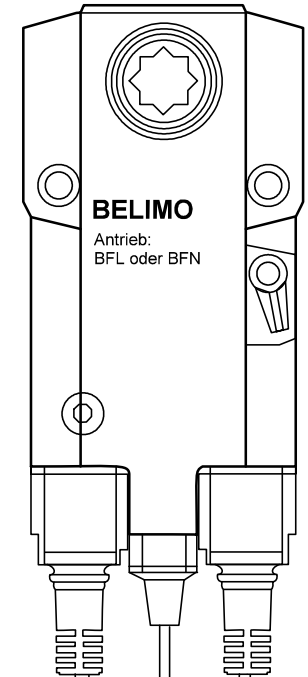
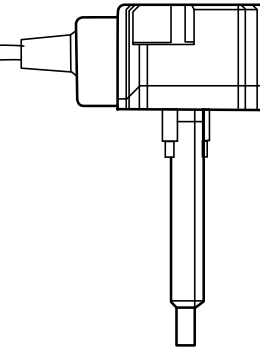

BC-24 G2

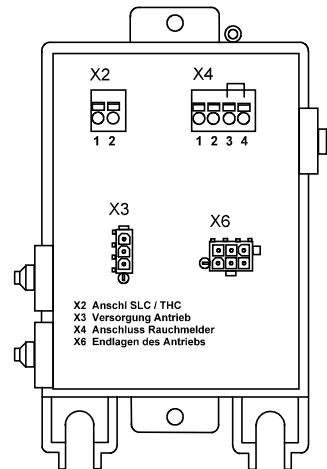

Endlagen
S1 bis S6

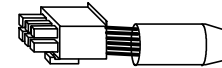

AC/DC 24V

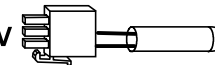

Schaltschrankebene

Feldebene

