

# Schaltschrankebene

Auswählbare digitale Kommunikations- und Steuergeräte:

**THC24-(1)B G2**  
für 1 Antrieb (Variante 3.1)



oder

**THC24-4B MP**  
für 4 Antrieb (Variante 3.2)



oder

**SLC24-8B**  
für 8 Antrieb (Variante 3.3)

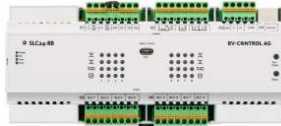

oder

**SLC24-16B**  
für 16 Antrieb (Variante 3.4)

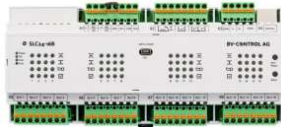

oder

**SLC230-24-2B**  
für 2 Antrieb (Variante 3.5)

**SLC230-24-4B**  
für 4 Antrieb (Variante 3.6)



# Feldebene

Zusätzliche Option  
Rauchmelder  
z.B. ORS 142 K

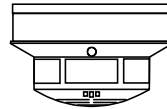

Thermoelektrische  
Auslöseeinrichtung:  
BAT72

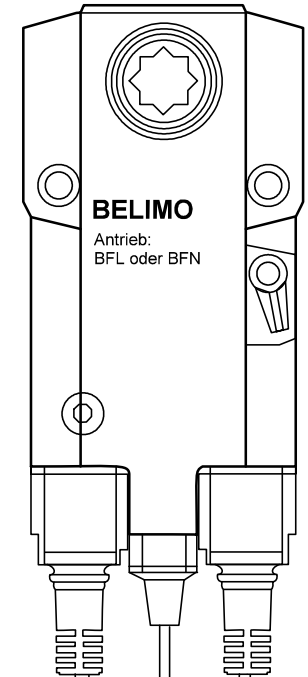
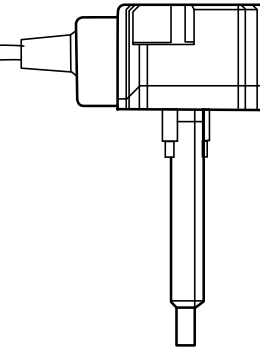

**BC-24 G2**

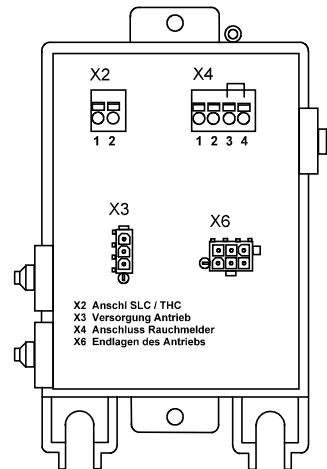

Endlagen  
S1 bis S6

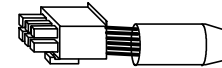

AC/DC 24V



# Schaltschrankebene

# Feldebene

